

## MINUS TWO - NEW CONSTRUCTION | LOW VOLTAGE INSTALLATION INSTRUCTIONS

Please read these instructions in their entirety prior to the start of the installation to ensure a proper and functional installation. Carefully review each step and confirm you have the necessary tools and compatible drivers to complete every step.

### WARNING & SAFETY INSTRUCTIONS

- DO NOT INSTALL DAMAGED PRODUCT! Upon receipt, thoroughly inspect for any freight damage which should be brought to the attention of the delivery carrier.
- Compare the catalog description listed on the packing slip with the label on the carton to ensure you have received the correct merchandise.
- Read and familiarize yourself with the nomenclature and instructions before starting installation.
- RISK OF ELECTRIC SHOCK! Turn off electricity at the breaker panel or fuse box and follow NEC and all local electrical building codes and practices.
- RISK OF INJURY! Avoid direct eye exposure to the light source while it is on.
- Do not install directly to line voltage! Remote power supply is required. Follow all instructions by the manufacturer!
- Do not power on fixture with lens protector installed.
- Avoid direct contact with light source. The fixture lens must have a minimum clearance of 1 foot (30cm) at all times.
- Do not submerge this product under water.
- Do not install incompatible dimmers with driver. Check dimmer compatibility on the driver cutsheet.

**THESE INSTRUCTIONS DO NOT PURPORT TO COVER ALL DETAILS OR VARIATIONS IN EQUIPMENT NOR TO PROVIDE FOR EVERY POSSIBLE CONTINGENCY TO BE MET IN CONNECTION WITH INSTALLATION, OPERATION OR MAINTENANCE. SHOULD FURTHER INFORMATION BE DESIRED OR SHOULD PARTICULAR PROBLEMS ARISE WHICH ARE NOT COVERED SUFFICIENTLY FOR THE CUSTOMER/OPERATOR'S PURPOSES THE MATTER SHOULD BE REFERRED TO APURE DISTRIBUTION, LLC.**

Failure to follow any of these instructions could void product warranties. For a complete listing of product Terms and Conditions, please visit [www.apurelighting.com](http://www.apurelighting.com). Apure assumes no responsibility for claims arising out of improper or careless installation or handling of its products.

### Resources / Installation Videos

Scan QR Code or visit at [apurelighting.com/resources/](http://apurelighting.com/resources/)



Resources



Videos



## MINUS TWO - New Construction

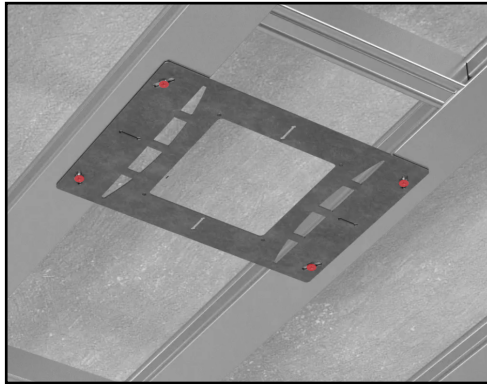

1. Separate the mounting bracket and mounting board and fasten the bracket to the framing in the desired fixture location.

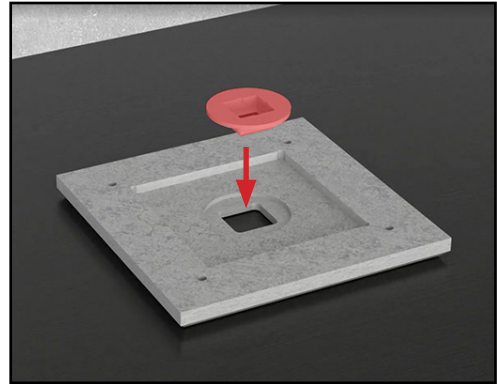

2. Insert the guard into the fiber board.

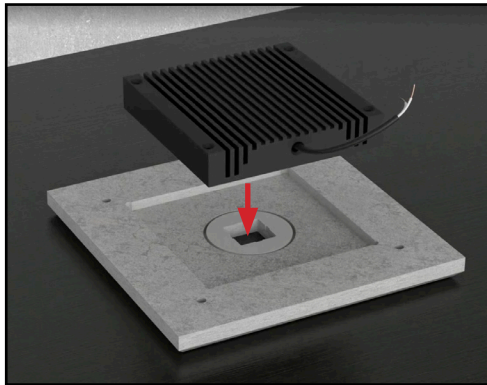

3. Take the Minus fixture and place it onto the mounting board.

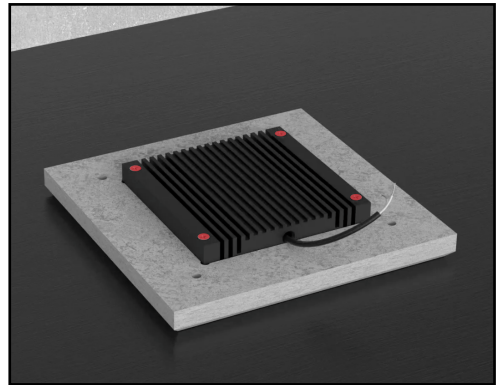

4. Secure the Minus fixture to the board by fastening the screws provided with the fixture.

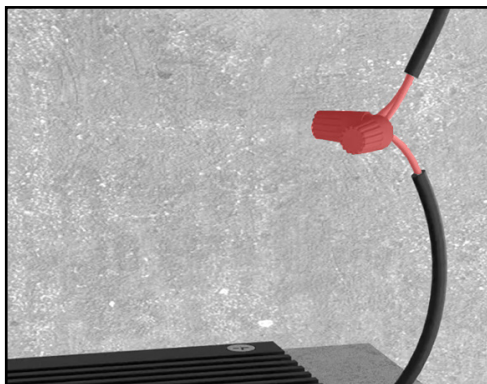

5. Feed **low voltage** wiring to the bracket and lift the fixture board assembly to the **low voltage** electrical connection and make the connection.

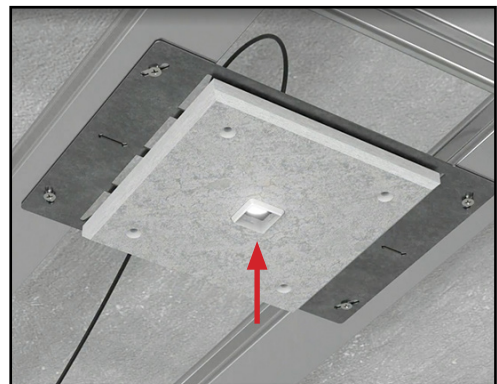

6. Test and confirm that the fixture is fully operational. Do not move on to the next step until the fixture is operational.

*Note: Please refer to wiring diagram on page 5.*

## MINUS TWO - New Construction. Cont'd

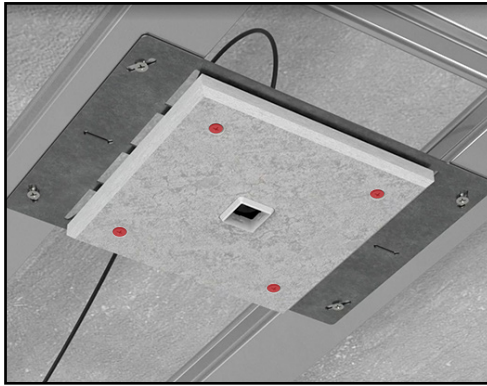

7. Secure the board to the drywall bracket using the provided screws.

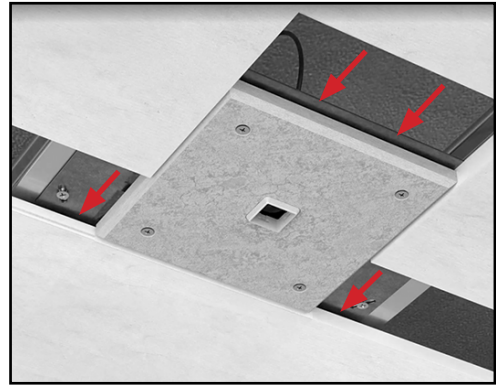

8. Cut and install the drywall around the fixture, ensuring that the fixture board assembly is flush with the surrounding drywall. This will allow a finish of one eighth inch of plaster around the finishing guard.

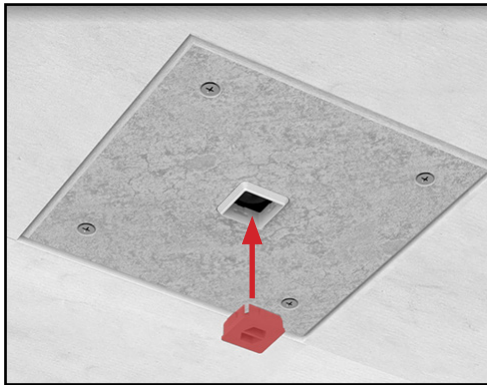

9. Insert the finishing guard into the fixture opening to prepare for finishing. The fixture must remain off for the remainder of the installation.

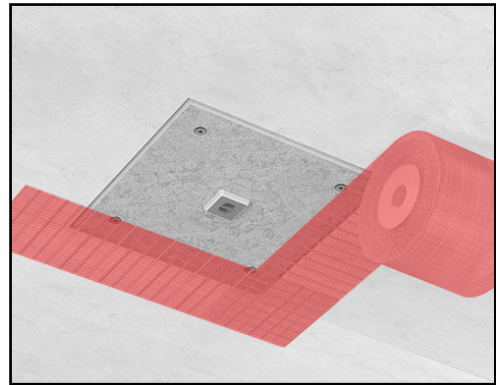

10. Tape the seams between the drywall board and ceiling. Joint compound may be used to fill any gaps before applying the tape.

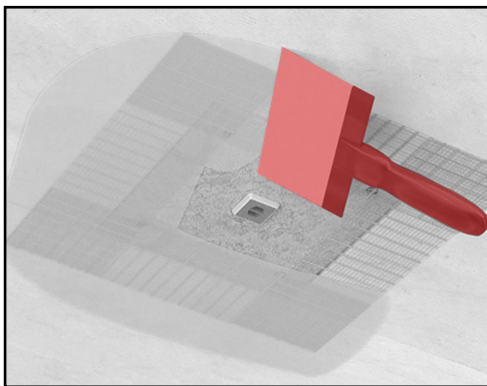

11. Allow for the tape to dry and apply your first coat of plaster to the tape seam, lightly skim coating the surface of the fixture board assembly.

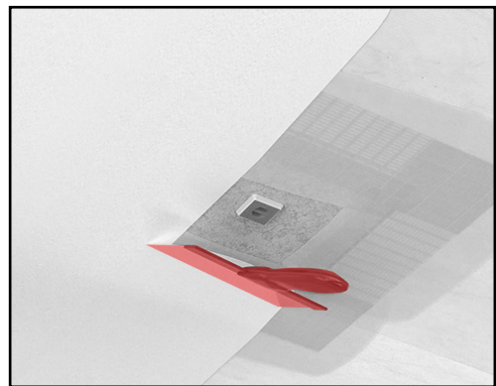

12. Apply the subsequent coat of plaster to level out the board with the existing drywall finish.

## MINUS TWO - New Construction, Cont'd.

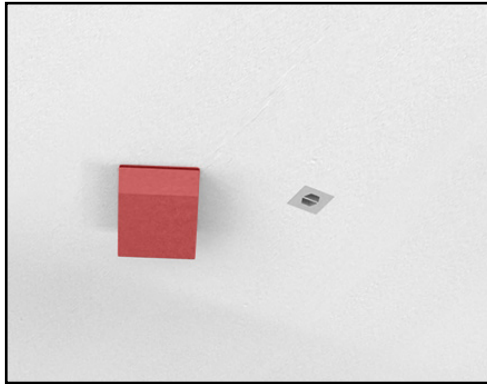

13. Allow for the surface to dry and sand the plastered ceiling.

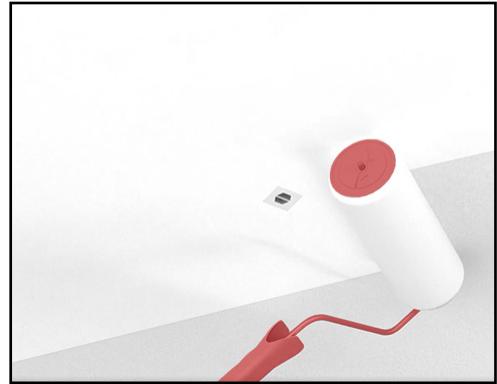

14. Paint the surface.

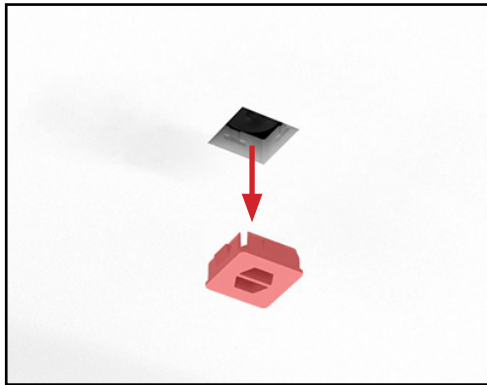

15. Carefully remove the finishing guard from the fixture opening.

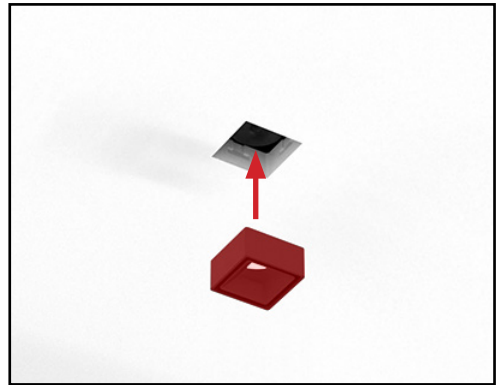

16. Insert the louver into the fixture opening to magnetically attach the louver.

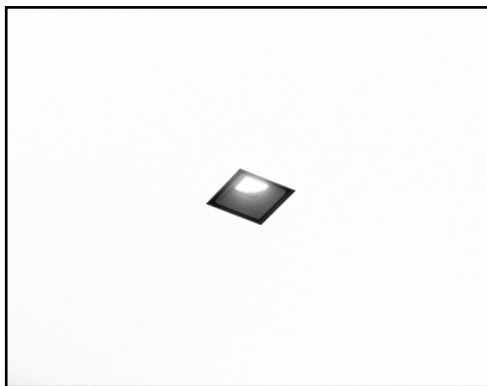

17. The installation is now complete.

**Wiring diagram on the following page.**

## Wiring Diagram for 12V Minus Products - [EU]

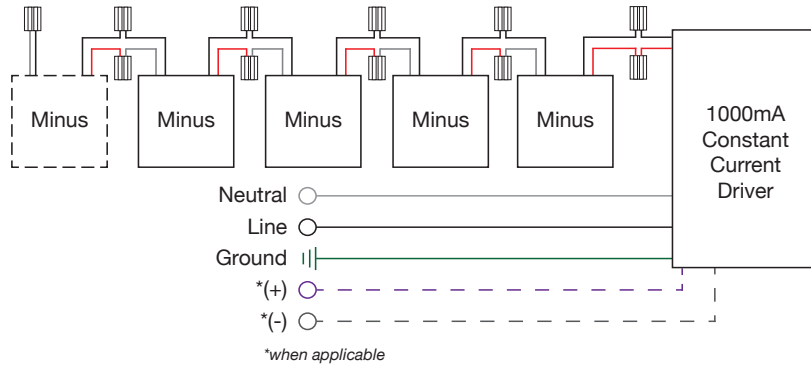

**Fixture Leads In**  
Red with Red (+)  
Black with Black (-)

**Fixture Leads Out**  
Black with Black  
White with Red

*Warning: failure to wire correctly may cause fixture to fail.*

*Note: The white and black cables of the last fixture in the series must be bridged together!*

### Additional Considerations

The above wiring diagram applies only to 12V Minus products with product ordering codes ending with "EU". The diagram above shows the typical wiring schematic, however the total number of fixtures per driver is driver specific.

- Magnitude AFLEX Power Supply (1000mA 60W) 1-4 Minus 16AWG - 82ft (25m)
- Apure Phase Dimmable (1000mA 29W) 1-2 Minus 16AWG - 82ft (25m)
- Apure Phase Dimmable (1000mA 30-65W) 3-5 Minus 16AWG - 82ft (25m)
- Apure DALI, Push, 1-10V (1000mA 30-65W) 1-4 Minus 16AWG - 82ft (25m)

**WARNING:** The power supply must operate within the range of minimum to maximum fixtures. Operation with less or more fixtures from the specified amount will result in damage to the power supply and/or lighting fixture. Incorrectly wiring the 12V EU lighting fixture may cause luminaire to fail.

## Wiring Diagram for 24V Minus Products - [A] MLV or [L] Lutron

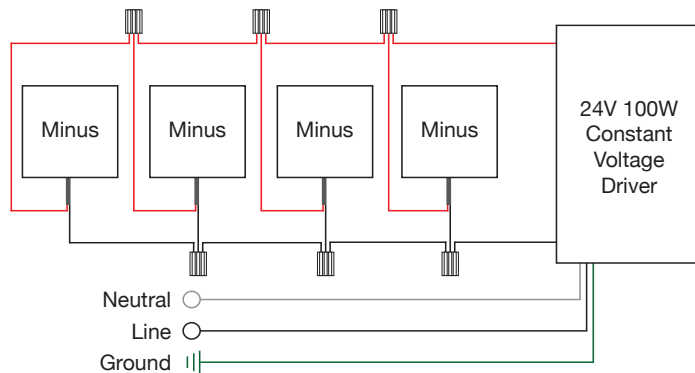

**Fixture Leads**  
Red (+)  
Black (-)

### Additional Considerations

The above wiring diagram applies only to 24V Minus products with product ordering codes ending with "A" or "L". The diagram above shows the typical wiring schematic, however the total number of fixtures per driver is driver specific.

- Magnitude Constant Voltage Driver (96W 24VDC) 1-4 Minus ≤16AWG - 150ft (45m)
- Lutron Hi-Lume Constant Voltage Driver (96W 24VDC) 1-4 Minus ≤16AWG - 150ft (45m)
- Lutron HomeWorks Constant Voltage Driver (96W 24VDC) 1-4 Minus ≤16AWG - 150ft (45m)

**WARNING:** The power supply must operate within the range of minimum to maximum fixtures. Operation with less or more fixtures from the specified amount will result in damage to the power supply and/or lighting fixture.